

ATRMMax II Variable Angle Horizontal ATR Accessory – *HATR for Inquisitive Minds*

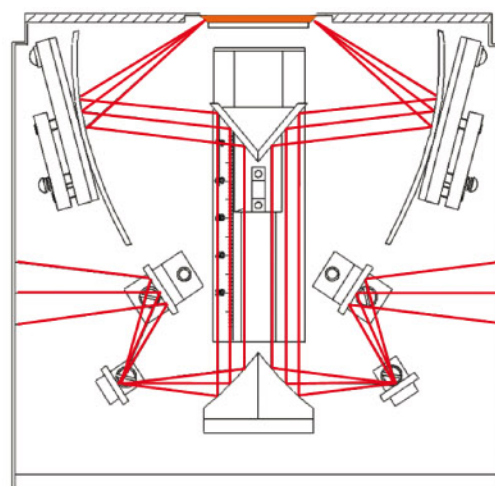

The ATRMax II is a high throughput, variable angle horizontal ATR accessory developed for use in FTIR spectrometers. The design employs a unique optical layout (U.S. patent 5,105,196) which enables samples to be analyzed over a range of incident angles from 25 to 65 degrees. Variable angle of incidence provides experimental control over the depth of penetration of an IR beam into the sample and the number of beam reflections in the ATR crystal, which in turn determines the effective IR beam pathlength for a given experiment. Adjustable angle of incidence allows immediate optimization of measurements for otherwise difficult to analyze samples. The ATRMax can be used for depth profiling studies where spectral composition may be analyzed relative to depth of penetration as the angle of incidence is changed.



Proprietary beam path within the ATRMax II FTIR sampling accessory.

FEATURES

- Selectable angle of incidence – 25 to 65 degrees in one degree increments
- 0.5 to 10 micron depth of penetration – dependent on crystal material, angle of incidence, sample's refractive index and wavelength of IR beam – ideal for depth profiling studies
- 3 to 12 reflections of IR beam – dependent upon angle of incidence – ideal for optimizing ATR sampling methods
- Flat and trough crystal plates for solids, films, powders and liquid samples – optional temperature control for all plates
- Optional, high-pressure clamp for sampling of films, coatings or powdered samples
- Automated option with electronic control module and AutoPRO™ software for high-precision experiments
- Sealed and purgeable optical design to eliminate water vapor and carbon dioxide interferences

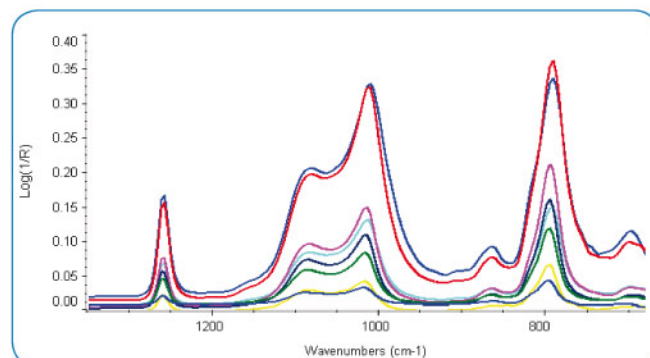

Depth profiling study of silicon release agent using ATRMax II accessory. FTIR spectra collected using Ge crystal flat plates at effective angles of incidence from 25 to 65 degrees.

The ATR crystals for the ATRMax II are of trapezoidal shape and 56-mm long, 10-mm wide and 4-mm thick. Standard bevel angles at each end of the crystal are available in 30, 45, and 60 degree versions. Coupling the variable angle of incidence of the ATRMax II with the variable crystal face angles, one can select effective angle of incidence ranging from 25 to 65 degrees and the range in number of reflections from 3 to 12.

Two crystal plate configurations, flat and trough, are available for the ATRMax II. The **flat crystal plate** design is used for the analysis of coatings, films and non-particulate solids. Typical applications include depth profiling studies and optimization of ATR spectral data. A sample clamp is required to provide intimate contact between the sample and crystal surface.

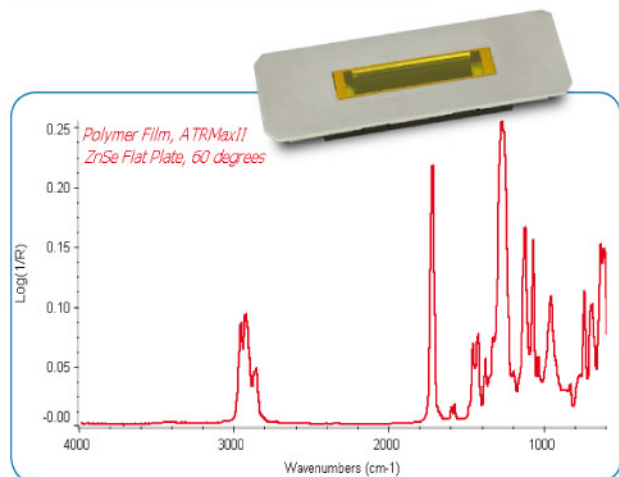

Optimized FTIR spectrum of polymer film run with the ATRMax II at 60 degree angle of incidence.

The **trough crystal plate** is recommended for use with liquids, pastes and powdered samples. Typical applications include the analysis of oils, detergents, and other liquid samples. A volatiles cover and powder press are included with the ATRMax II for use with this crystal plate style.

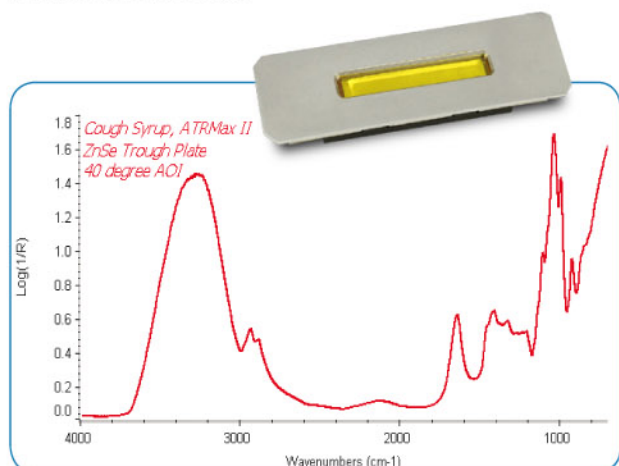

Liquid cough syrup sample spectrum collected with the ATRMax II accessory using the ZnSe trough plate and a 40 degree angle of incidence.

For special applications where you need to look at coatings on an ATR crystal, PIKE Technologies offers the RCPlate™ option. The RCPlate is designed to enable easy removal and reinsertion of the ATR crystal. Applications include analysis of coatings, monomolecular layers, or bio-films deposited directly upon the ATR crystal. With these RCPlates, it is easy to collect the background spectrum on the clean crystal, remove the ATR crystal from the RCPlate, coat the crystal and then reposition it into the RCPlate to collect the sample spectrum.

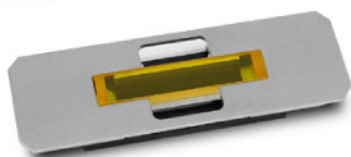

A variety of **Flow-Through Cells** are available which feature removable crystals. This enables replacement of the crystals and facilitates cleaning of “sticky” samples. Flow cells may be configured for ambient measurements and heating and liquid jacketed temperature control. With the liquid jacketed version one can measure samples at heated or cooled temperatures using a liquid circulator. PTFE coating of the cell is an option.



Optional **Resistively Heated Crystal Plates** are available for the ATRMax II trough, flat and flow-through cell versions. These heated crystal plates are driven using the PIKE Technologies' temperature control module. PIKE TempPRO software is available for graphical setup of ramp and soak temperature profiling studies and interfaces with most FTIR software packages for data collection.



The variable angle of incidence can be controlled manually or with an optional **motorized attachment** for the ATRMax II. Multiple ATR measurements at different angles of incidence can be fully automated with the motorized version and PIKE Technologies' AutoPRO software. Automation streamlines the collection of spectra from multiple angles of incidence. With the automated ATRMax accessory, the entire experiment can be pre-programmed and executed by the computer. Advantages of the automated ATRMax II system include:

- Computer controlled precision, accuracy and repeatability
- Synchronization of mirror position changes with collection of sample spectra
- Full integration of the PIKE Technologies AutoPRO software with most FTIR spectrometer programs
- Tailor-made, predefined experiments
- “Hands-free” operation

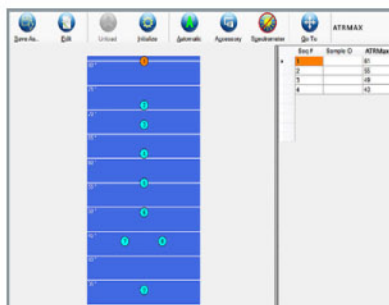

AutoPRO Software control of ATRMax angle of incidence (automated polarizer available) for automated depth profiling studies and ATR experiment optimization.

ORDERING INFORMATION

ATRMAX II SYSTEM CONFIGURATIONS

PART NUMBER	DESCRIPTION
023-10XX	ATRMMax II Trough Plate System with 45° ZnSe Crystal <i>Includes Trough Plate, Volatiles Cover and Powder Press</i>
023-11XX	ATRMMax II Flat Plate System with 45° ZnSe Crystal <i>Includes Flat Plate and Pressure Clamp</i>
023-12XX	ATRMMax II Combined Trough and Flat Plate System with 45° ZnSe Crystals <i>Includes Trough Plate, Flat Plate, Volatiles Cover, Powder Press and Pressure Clamp</i>

Notes: Replace **XX** with your spectrometer's Instrument Code listed on page 164. ATRMax II Systems may be purchased with crystal plates other than ZnSe. Just add -Ge for germanium, -KR for KRS-5, -AM for AMTIR, or -Si for Silicon. Additional plates can be added to an order for any system above. Other configurations may be selected from the options below.

ATRMMax II BASE OPTICS

(must select)

PART NUMBER	DESCRIPTION
023-19XX	ATRMMax II Variable Angle HATR

Notes: Replace **XX** with your spectrometer's Instrument Code listed on page 164. ATRMax II Base Optics includes volatiles cover, powder press, purge tubes, purge kit and spectrometer base mount.

CRYSTAL PLATES FOR ATRMAX II

(must select 1 or more)

PART NUMBER	DESCRIPTION
023-2001	Trough Plate, ZnSe, 45°
023-2011	Flat Plate, ZnSe, 45°
023-2021	Trough Plate, ZnSe, 30°
023-2031	Flat Plate, ZnSe, 30°
023-2041	Trough Plate, ZnSe, 60°
023-2051	Flat Plate, ZnSe, 60°
023-2003	Trough Plate, Ge, 45°
023-2013	Flat Plate, Ge, 45°
023-2023	Trough Plate, Ge, 30°
023-2033	Flat Plate, Ge, 30°
023-2043	Trough Plate, Ge, 60°
023-2053	Flat Plate, Ge, 60°
023-2046	Trough Plate, AMTIR, 45°
023-2047	Flat Plate, AMTIR, 45°
023-2002	Trough Plate, KRS-5, 45°
023-2012	Flat Plate, KRS-5, 45°
023-2022	Trough Plate, KRS-5, 30°
023-2032	Flat Plate, KRS-5, 30°
023-2042	Trough Plate, KRS-5, 60°
023-2052	Flat Plate, KRS-5, 60°
023-2044	Trough Plate, Si, 45°
023-2045	Flat Plate, Si, 45°

Notes: ATRMax crystal plates are pre-aligned and pinned-in-place. Changing crystal plates to optimize sampling results is easy and fast. If you need a crystal plate not listed here, please contact us.

PRESSURE CLAMP FOR ATRMAX II

PART NUMBER	DESCRIPTION
023-3050	ATRMMax Pressure Clamp

Note: The pressure clamp is required for solids, films, coatings and powdered samples.

ATRMMax II SAMPLING OPTIONS

PART NUMBER	DESCRIPTION
023-2800	Automated Upgrade for ATRMax II
023-2850	Automated Option for ATRMax II
023-2300	RCPlate for ATRMax II
023-4000	ATRMMax Flow Cell Assembly (order crystal separately)
023-4100	ATRMMax Liquid-Jacketed Flow-Through Cell Assembly (order crystal separately)
023-4200	ATRMMax Heated Flow-Through Cell Assembly (order crystal separately)
023-4300	ATRMMax Heated Trough Plate Assembly (order crystal separately)
023-4400	ATRMMax Heated Flat Plate Assembly (order crystal separately)
013-4200	ATR Variable Angle Heating Conversion Plate
076-1610	Digital Temperature Control Module
007-0207	PIKE TempPRO Software

Notes: Automated option includes PIKE AutoPRO software and controller. Other polarizer options are found in the polarization section of this catalog. The ATR Variable Angle Heating Conversion Plate must be selected with temperature controlled crystal plates. Resistively heated crystal plates require selection of the Temperature Control Module. Maximum crystal temperature is 120 °C. If PC control is desired, PIKE TempPRO software (sold separately) can be used for graphical setup and automated data collection with most FTIR spectrometers for thermal experiments.

CRYSTALS FOR ATRMAX II

PART NUMBER	DESCRIPTION
160-5563	Crystal, 45°, Trap., 56 x 10 x 4, ZnSe
160-5571	Crystal, 60°, Trap., 56 x 10 x 4, ZnSe
160-5569	Crystal, 30°, Trap., 56 x 10 x 4, Ge
160-5565	Crystal, 45°, Trap., 56 x 10 x 4, Ge
160-5573	Crystal, 60°, Trap., 56 x 10 x 4, Ge
160-5570	Crystal, 30°, Trap., 56 x 10 x 4, Si
160-5567	Crystal, 45°, Trap., 56 x 10 x 4, Si
160-5575	Crystal, 60°, Trap., 56 x 10 x 4, Si
160-5566	Crystal, 45°, Trap., 56 x 10 x 4, AMTIR
160-5574	Crystal, 60°, Trap., 56 x 10 x 4, AMTIR



Note: Please contact PIKE Technologies for crystals not on this list.

ATRMMax II REPLACEMENT PARTS

PART NUMBER	DESCRIPTION
023-3051	ATRMMax II Volatiles Cover
023-3052	ATRMMax II Powder Press

Notes: Please contact PIKE Technologies for items not described in this list. Reconditioning service for used ATRMax crystal plates is available.

RESISTIVELY HEATED PLATES SPECIFICATIONS

Temperature Range	Ambient to 120 °C
Accuracy	+/- 0.5% of set point
Sensor Type	3 wire Pt RTD (low drift, high stability)
Temperature Control	Touch-panel display with USB interface. PIKE TempPRO software (sold separately) for PC control with unlimited ramps and automated data collection.
  	
Input	100–240 VDC, auto setting, external power supply
Output	24 VDC/36 W maximum



JASCO France
17 Rue des Cerisiers
91090 Lisses - France

Tél. 01 64 97 09 60 Fax: 01 85 09 90 76
email: jascofrance@jascofrance.fr