

HPLC/UHPLC COLUMNS

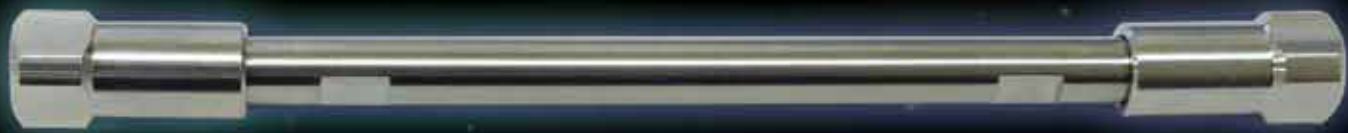

HORIZON
CHROMATOGRAPHY LTD.

HPLC/UHPLC COLUMNS

Our Future Mission

“Horizon Chromatography is simply unique. After decades working within the fields of analytical chemistry and column chemistry, Horizon Chromatography was formed by a talented team of technical experts to tackle issues within the analytical industry. Horizon is focused on tackling chromatography column issues from the industrial and research sectors, issues of pre and post service, technical advice, support, distribution and supply issues.”



HORIZON
CHROMATOGRAPHY LTD.

Our mission is to provide;

A comprehensive range of robust HPLC and UHPLC columns that are competitively priced and distributed to the customer without delay

Columns that provide excellent peak shape and long lasting performance

Columns that are batch tested using rigorous quality control testing

Superb sales service both at the point of order and following delivery

Technical assistance to aid the customer's method development process

Horizon Chromatography invites you, the customer, to step into a better future

HORIZON

AVAILABLE FROM HORIZON CHROMATOGRAPHY

> Aurashell, Core-shell Particles

- Monodisperse core-shell particle technology offering both high speed and high efficiency separations
- Uniform packed bed columns with no back pressure concerns for the analyst
- Multiple particle sizes and phase chemistries available

- Aurashell 90Å
 - C18
 - C18/PFP
 - Aqua C18
 - HILIC
- Aurashell PEP C18
 - 160Å Peptide C18
- Aurashell PRO C4
 - 300Å Protein C4

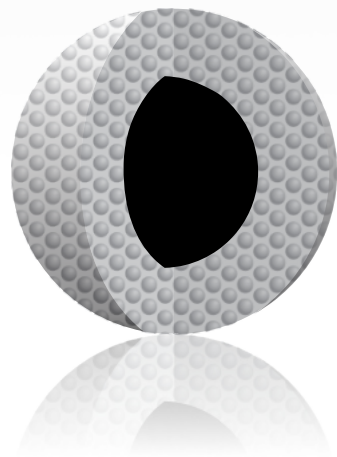

> 1.6µm Horizon UHPLC particles

- Fully porous ultra pure ultra inert silica
- Provides excellent peak shapes and reproducibility
- High efficiency UHPLC columns with good retention and sample loading
- Multiple Horizon phase chemistries available, fully scalable across multiple formats

- 1.6µm Horizon C18
- 1.6µm Horizon C18/PFP
- 1.6µm Horizon Aqua C18
- 1.6µm Horizon C8
- 1.6µm Horizon HILIC
- 1.6µm Horizon Phenyl
- 1.6µm Horizon Amino
- 1.6µm Horizon Cyano



"Horizon is focused on offering the analytical community the flexibility to choose between both techniques"

FUTURE PROOF YOUR SUCCESS

> Horizon Phase Chemistry Highlights...

Horizon's comprehensive range of phase chemistries provide excellent performance and lifetime. Selectivity is key in providing the analyst with the tools to perform their method development and analysis.

Horizon C18 provides excellent peak shapes for difficult to analyse compounds and is robust at extremes of high and low pH

Horizon C18/PFP offers selectivity unmatched by virtually all commercial C18 products on the market. With the addition of the PFP ligand to the bonded surface, the Horizon C18/PFP provides the extra unique PFP selectivity that helps resolve co-eluting compounds



Horizon Aqua C18 has been developed to separate highly polar compounds in reverse phase conditions. Polar endcapping allows analysis in 100% aqueous mobile phase conditions.

> BIO phases for biomolecule analysis

- Based on ultra pure inert silica
- Provides excellent peak shapes and reproducibility
- Multiple pore diameter options
- Available in both fully porous and core-shell formats

- Horizon PEP C18
 - 200Å Peptide C18
- Horizon PRO C4
 - 300Å Protein C4
- Aurashell PEP C18
 - 160Å Peptide C18
- Aurashell PRO C4
 - 300Å Protein C4

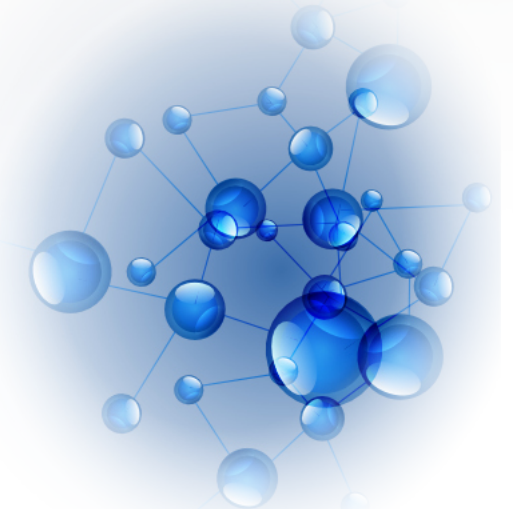

AURASHELL C18

CORE-SHELL COLUMNS

Based on ultra pure core-shell silica, Aurashell C18 delivers high speed efficiency separations for a wide range of analytes.

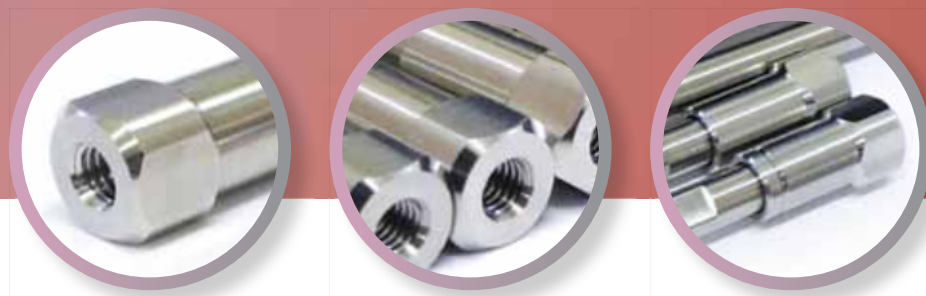

HORIZON HEADS UP

"If an increase in both analytical speed and resolution are key, but instrument configuration and method transfer are a concern, then Aurashell C18 is the way forward. remember to reduce any system void volume to get the most from your Aurashell column"

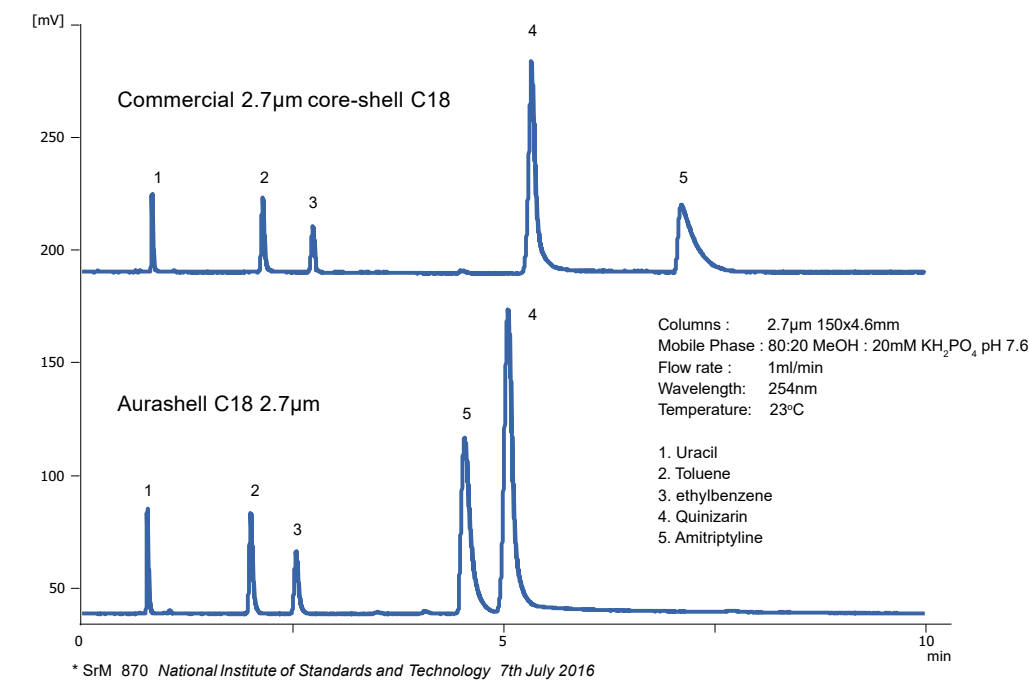
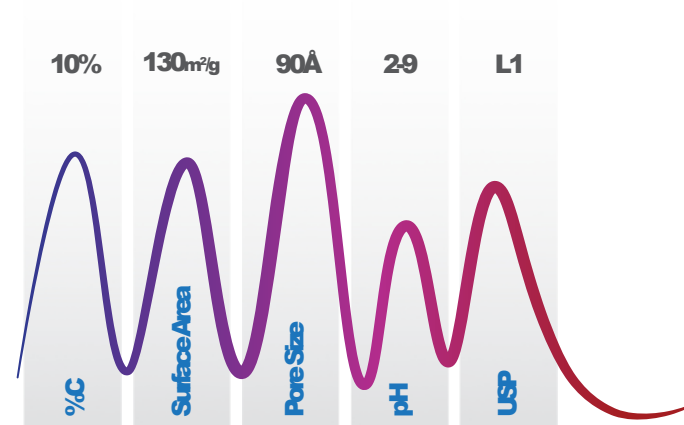

AURASHELL C18

- Ultra high column efficiencies with excellent peak shapes
- Increased resolution over equivalent size porous particles
- Improved speed of analysis combined with phase stability across a wide pH range
- Uniform packed bed leads to better and more efficient separations
- Aurashell columns can be used on any type of HPLC system as there is no requirement to run at elevated back pressure

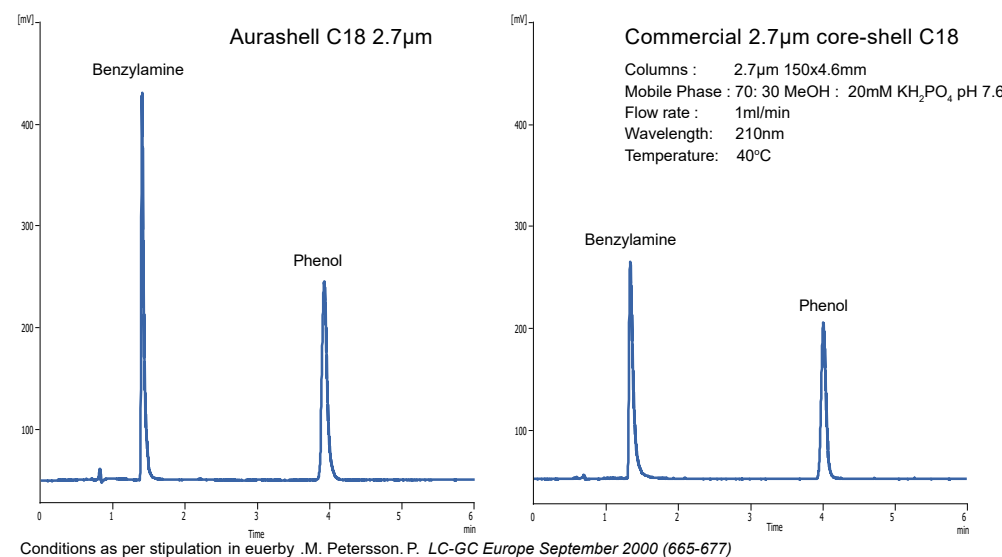

Column Length (mm)	Column Diameter (mm)			
	2.1	3.0	4.0	4.6
30	AS18-030-21-DP	AS18-030-30-DP	AS18-030-40-DP	AS18-030-46-DP
50	AS18-050-21-DP	AS18-050-30-DP	AS18-050-40-DP	AS18-050-46-DP
75	AS18-075-21-DP	AS18-075-30-DP	AS18-075-40-DP	AS18-075-46-DP
100	AS18-100-21-DP	AS18-100-30-DP	AS18-100-40-DP	AS18-100-46-DP
125	AS18-125-21-DP	AS18-125-30-DP	AS18-125-40-DP	AS18-125-46-DP
150	AS18-150-21-DP	AS18-150-30-DP	AS18-150-40-DP	AS18-150-46-DP
10mm Guard pk 4	AS18-G10-21-DP	AS18-G10-30-DP	AS18-G10-40-DP	AS18-G10-46-DP

replace DP with : 27 for 2.7µm 50 for 5µm

Guard Holder - HGH1

AURASHELL C18/PFP

CORE-SHELL COLUMNS

The C18/PFP functionality offers alternative selectivity over traditional C18 coupled with the advantages of the Aurashell core-shell technology.



HORIZON HEADS UP

“Switching to a mobile phase that is a mix of methanol and water/buffer will enhance the multi-mode separation mechanisms that the Aurashell C18/PFP provides”

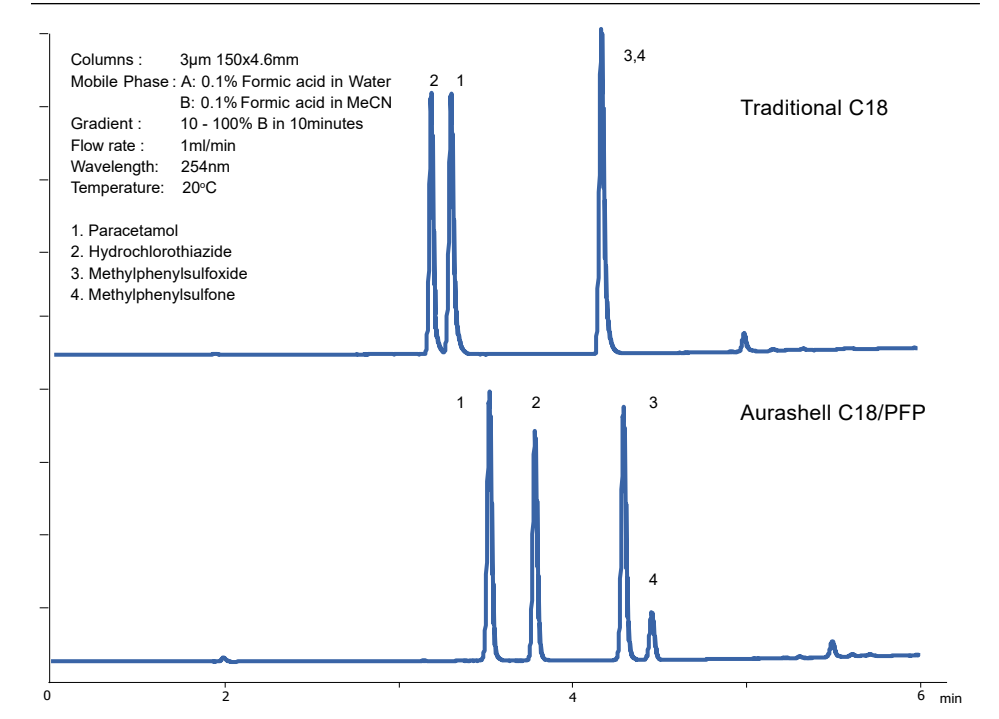
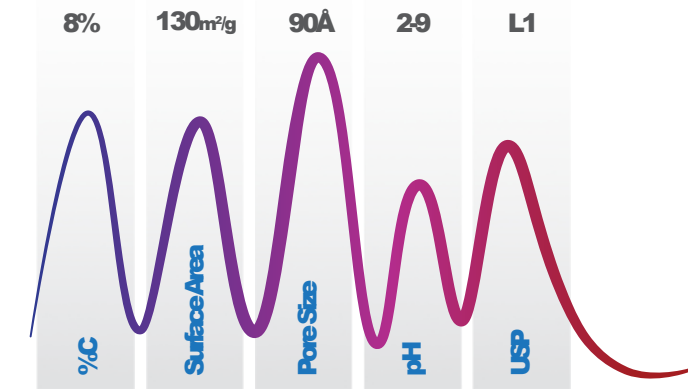

AURASHELL C18/PFP

- Available in 2.7µm and 5µm particle size options
- Separate problematic analyte mixtures
- Combines traditional C18 with the additional selectivity of PFP
- Uniform packed bed leads to better and more efficient separations
- Aurashell columns can be used on any type of HPLC system as there is no requirement to run at elevated back pressure

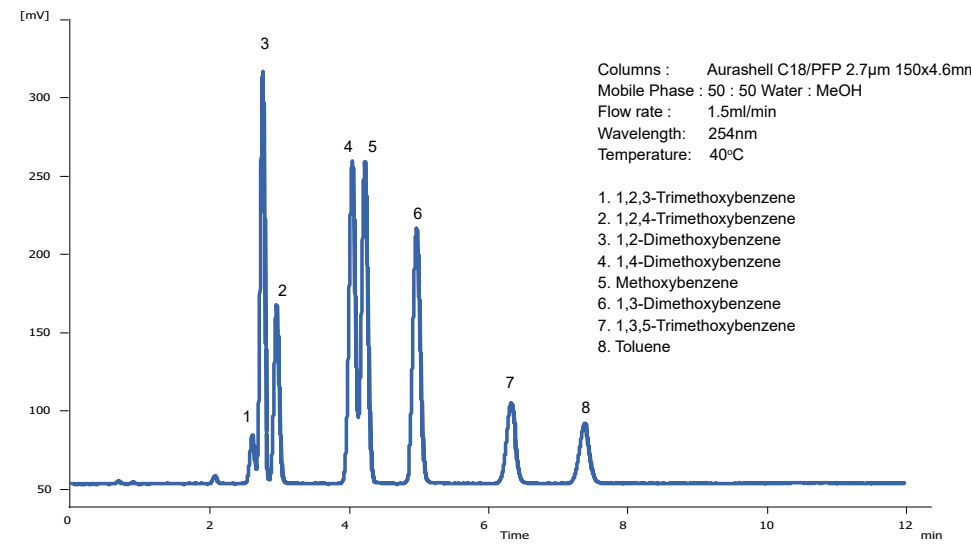

Column Length (mm)	Column Diameter (mm)			
	2.1	3.0	4.0	4.6
30	ASPF18-030-21-DP	ASPF18-030-30-DP	ASPF18-030-40-DP	ASPF18-030-46-DP
50	ASPF18-050-21-DP	ASPF18-050-30-DP	ASPF18-050-40-DP	ASPF18-050-46-DP
75	ASPF18-075-21-DP	ASPF18-075-30-DP	ASPF18-075-40-DP	ASPF18-075-46-DP
100	ASPF18-100-21-DP	ASPF18-100-30-DP	ASPF18-100-40-DP	ASPF18-100-46-DP
125	ASPF18-125-21-DP	ASPF18-125-30-DP	ASPF18-125-40-DP	ASPF18-125-46-DP
150	ASPF18-150-21-DP	ASPF18-150-30-DP	ASPF18-150-40-DP	ASPF18-150-46-DP
10mm Guard pk 4	ASPF18-G10-21-DP	ASPF18-G10-30-DP	ASPF18-G10-40-DP	ASPF18-G10-46-DP

replace DP with : 27 for 2.7µm 50 for 5µm

Guard Holder - GHG1

AURASHELL AQUA C18

CORE-SHELL COLUMNS

The Aurashell Aqua C18 has been developed to separate very polar compounds in reversed phase conditions of up to 100% aqueous mobile phase. Polar endcapping and core-shell technology combine to give rapid analysis of polar compounds.

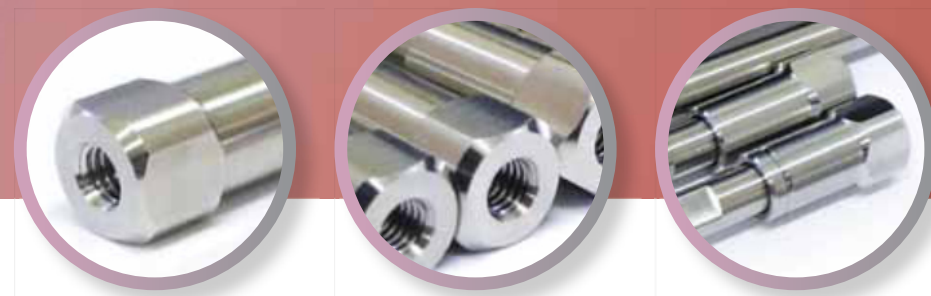

HORIZON HEADS UP

“The Aurashell Aqua C18 offers not only a robust solution to the analysis of polar compounds but the Aurashell technology means it can be done with savings in terms of analysis time and eluent”

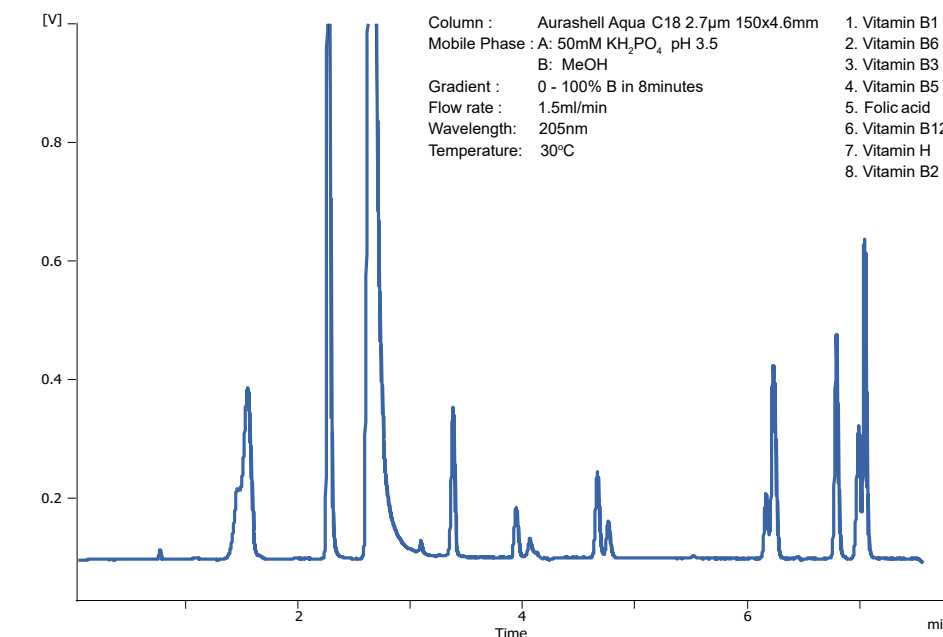
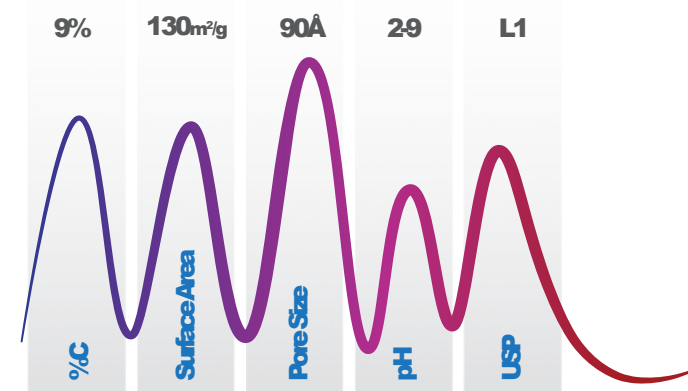

AURASHELL AQUA C18

- Unique polar endcapped C18 phase chemistry providing excellent peak shapes
- resistant to phase collapse in 100% aqueous mobile phase
- retains polar compounds in 100% Aqueous mobile phase
- Fast equilibration for wide ranging gradient applications
- No loss of performance or retention with repeated use in 100% aqueous mobile phase

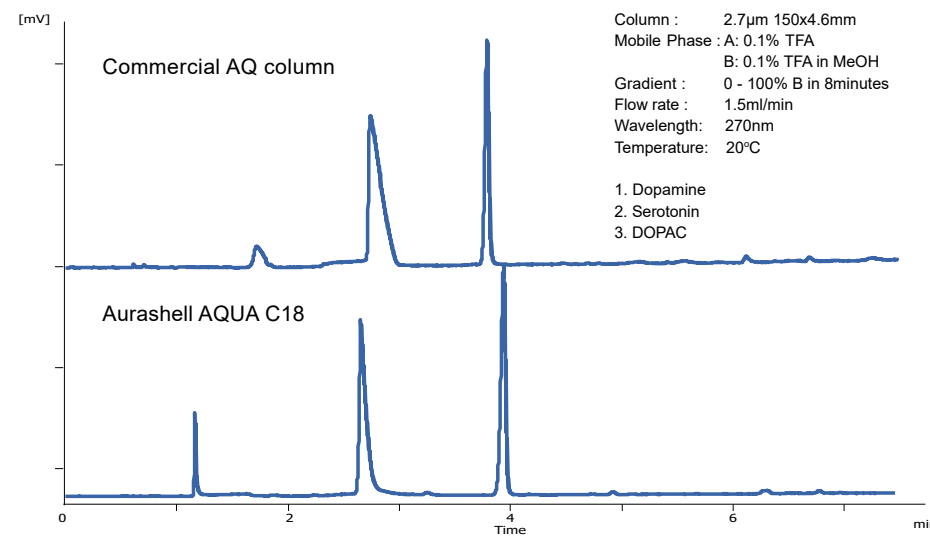

Column Length (mm)	Column Diameter (mm)			
	2.1	3.0	4.0	4.6
30	ASQA-030-21-DP	ASQA-030-30-DP	ASQA-030-40-DP	ASQA-030-46-DP
50	ASQA-050-21-DP	ASQA-050-30-DP	ASQA-050-40-DP	ASQA-050-46-DP
75	ASQA-075-21-DP	ASQA-075-30-DP	ASQA-075-40-DP	ASQA-075-46-DP
100	ASQA-100-21-DP	ASQA-100-30-DP	ASQA-100-40-DP	ASQA-100-46-DP
125	ASQA-125-21-DP	ASQA-125-30-DP	ASQA-125-40-DP	ASQA-125-46-DP
150	ASQA-150-21-DP	ASQA-150-30-DP	ASQA-150-40-DP	ASQA-150-46-DP
10mm Guard pk 4	ASQA-G10-21-DP	ASQA-G10-30-DP	ASQA-G10-40-DP	ASQA-G10-46-DP

replace DP with : 27 for 2.7µm 50 for 5µm

Guard Holder - HGH1

AURASHELL HILIC

CORE-SHELL COLUMNS

The Aurashell HILIC delivers fast and efficient separations for highly polar compounds. Aurashell HILIC offers stable and reproducible chromatography and is ideal for polar hydrophilic compounds.



- %C - n/a
- Surface area - 130 m²/g
- Pore size - 90Å
- pH range - 2-8
- USP - L3

Column Length (mm)	Column Diameter (mm)			
	2.1	3.0	4.0	4.6
30	ASHIL-030-21-DP	ASHIL-030-30-DP	ASHIL-030-40-DP	ASHIL-030-46-DP
50	ASHIL-050-21-DP	ASHIL-050-30-DP	ASHIL-050-40-DP	ASHIL-050-46-DP
75	ASHIL-075-21-DP	ASHIL-075-30-DP	ASHIL-075-40-DP	ASHIL-075-46-DP
100	ASHIL-100-21-DP	ASHIL-100-30-DP	ASHIL-100-40-DP	ASHIL-100-46-DP
125	ASHIL-125-21-DP	ASHIL-125-30-DP	ASHIL-125-40-DP	ASHIL-125-46-DP
150	ASHIL-150-21-DP	ASHIL-150-30-DP	ASHIL-150-40-DP	ASHIL-150-46-DP
10mm Guard pk 4	ASHIL-G10-21-DP	ASHIL-G10-30-DP	ASHIL-G10-40-DP	ASHIL-G10-46-DP

replace DP with : 27 for 2.7µm 50 for 5µm

Guard Holder - HGH1

GUARD COLUMNS

COLUMN PROTECTION

> Pre Column Filters

Horizon Analytical HPLC Pre-column filter

- Cost effective protection for HPLC columns
- 400 bar pressure rating
- 2µm porosity
- Simple to install, finger tighten
- Compatible with all HPLC systems



Horizon Analytical Pre-column Filter PEEK 2µm porosity stainless steel filter, 5pk	HPCF-AN20-05
Horizon Analytical Pre-column Filter PEEK 2µm porosity stainless steel filter, 10pk	HPCF-AN20-10

Horizon UHPLC Pre-column filter

- Cost effective protection for UHPLC columns
- 1000 bar pressure rating
- 0.5µm porosity
- Wrench tighten
- Compatible with all UHPLC/HPLC systems
- Acquity® compatible version also available



Horizon UHPLC Pre-column Filter 0.5µm porosity stainless steel filter, 5pk	HPCF-UHP-05
Horizon UHPLC Pre-column Filter 0.5µm porosity stainless steel filter, 10pk	HPCF-UHP-10
Horizon UHPLC Pre-column Filter Acquity® Compatible, 5pk	HPCF-UHPW-05
Horizon UHPLC Pre-column Filter Acquity® Compatible, 10pk	HPCF-UHPW-10

> Guard Cartridges

Horizon Guard Cartridges

- Horizon guard cartridges significantly increase the lifetime of all HPLC columns
- Guard cartridges prevent the contamination and particulate build up on the column being used
- Available for all phase chemistries and column diameters



See product pages for specific guard cartridge part numbers

Horizon Guard Holder Suitable for all cartridges, 1pk	HGH1
---	------

AURASHELL PEPC18

WIDE PORE CORE-SHELL COLUMNS

The Aurashell PePC18 phase has been developed to deliver complex peptide analysis by providing increased peak capacity and resolution on any HPLC system.



HORIZON HEADS UP

“Prior to storing the column after use ensure all biologically active contaminants have been purged from the column. If the column has previously been used with a buffered mobile phase, the buffer should be flushed from the column before storage”

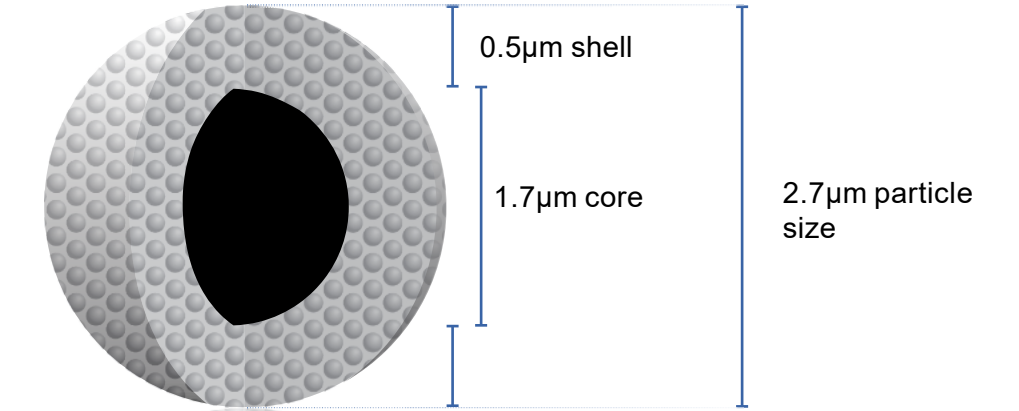
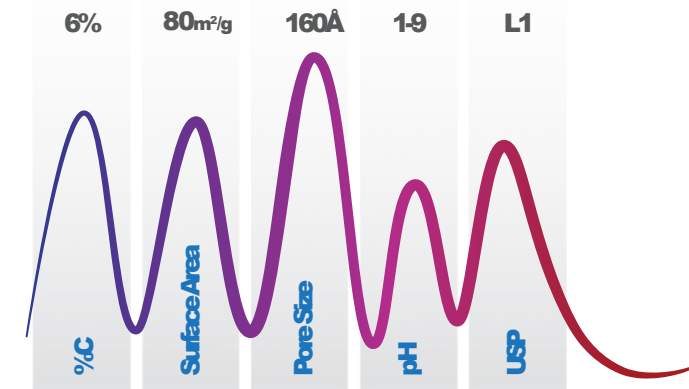

The porous shell of Aurashell particles provides a decreased diffusion path length, thereby reducing the time it takes for biomolecules to adsorb/desorb in to and out of the particles

2.7µm AUrASHeLL PePC18

- Pore structure optimised for protein and peptide fragment diffusion
- recommended for separation of low molecular weight peptides and peptide mapping
- Identification of protein modifications and analysis of post-translational modifications
- Peptide resolution and peak shape not compromised by reduced run times

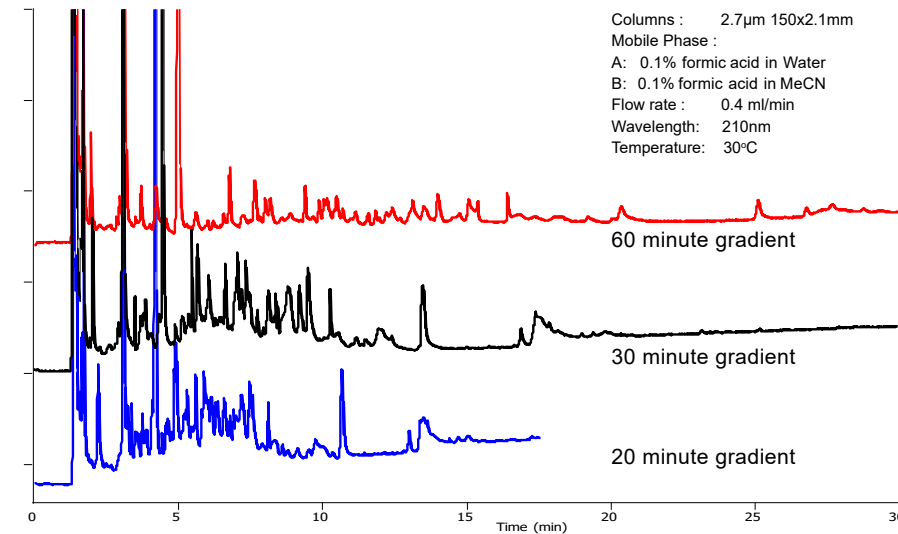

Column Length (mm)	Column Diameter (mm)			
	2.1	3.0	4.0	4.6
30	ASPeP18-030-21-27	ASPeP18-030-30-27	ASPeP18-030-40-27	ASPeP18-030-46-27
50	ASPeP18-050-21-27	ASPeP18-050-30-27	ASPeP18-050-40-27	ASPeP18-050-46-27
75	ASPeP18-075-21-27	ASPeP18-075-30-27	ASPeP18-075-40-27	ASPeP18-075-46-27
100	ASPeP18-100-21-27	ASPeP18-100-30-27	ASPeP18-100-40-27	ASPeP18-100-46-27
125	ASPeP18-125-21-27	ASPeP18-125-30-27	ASPeP18-125-40-27	ASPeP18-125-46-27
150	ASPeP18-150-21-27	ASPeP18-150-30-27	ASPeP18-150-40-27	ASPeP18-150-46-27
10mm Guard pk 4	ASPeP18-G10-21-27	ASPeP18-G10-30-27	ASPeP18-G10-40-27	ASPeP18-G10-46-27

Guard Holder - HGH1

AURASHELL PROC4

WIDE PORE CORE-SHELL COLUMNS

The Aurashell PrO C4 was designed for protein separations in acidic pH mobile phases. Featuring optimised shell thickness for shorter diffusion and wide pores for maximum analyte interaction.



HORIZON HEADS UP

“For very large, heterogenous proteins Aurashell PrO C4 columns give the best peak shape. Uniform size and shape of the Aurashell particle reduces loss of efficiency and performance due to band broadening”

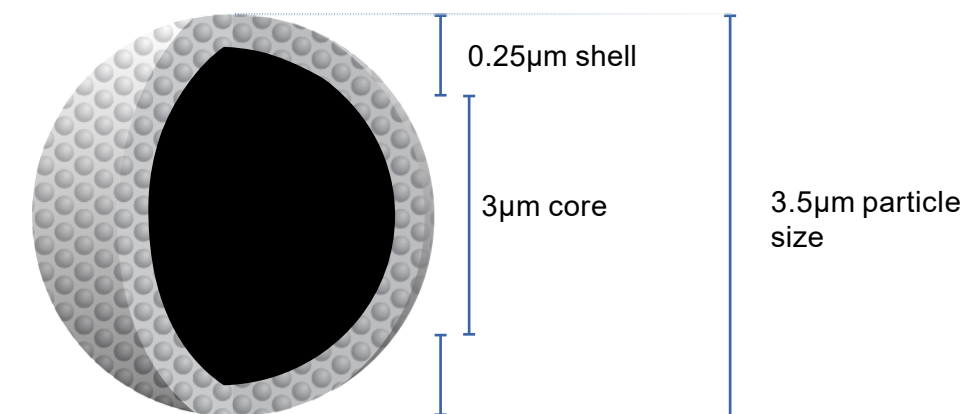
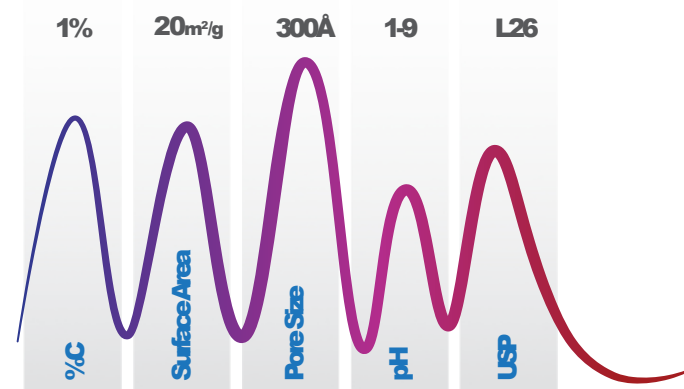

The reduced diameter porous shell of Aurashell particles provides a decreased diffusion path length, thereby reducing the time it takes for biomolecules to adsorb/desorb in to and out of the particles

3.5µmAUrASHeLL PrOC4

- Superficially porous particles bonded with short C4 stationary phase ligand
- recommended for separation of polypeptides, proteins and antibodies
- Low hydrophobicity phase necessary for the elution of very hydrophobic proteins
- Improved peak capacity and speed of analysis
- High resolution, high recovery and high reproducibility

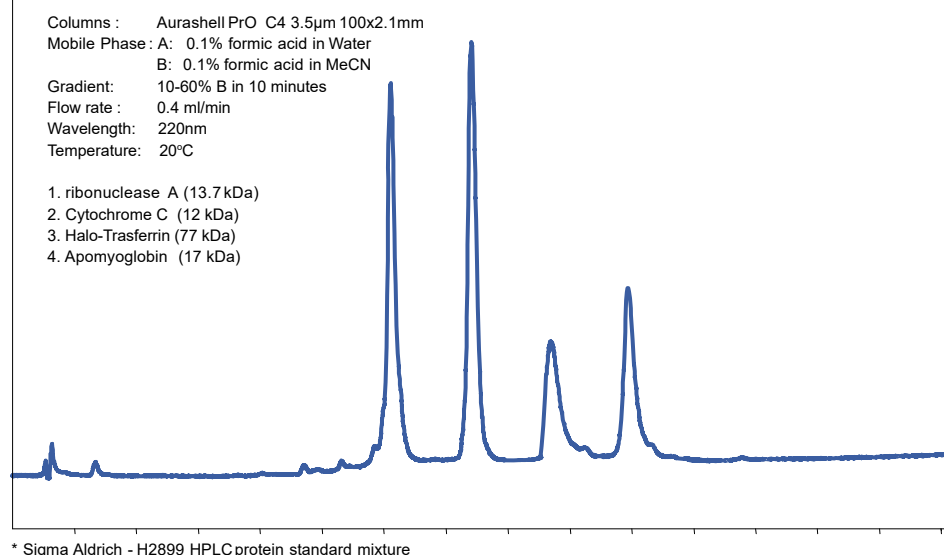

Column Length (mm)	Column Diameter (mm)			
	2.1	3.0	4.0	4.6
30	ASPrO04-030-21-35	ASPrO04-030-30-35	ASPrO04-030-40-35	ASPrO04-030-46-35
50	ASPrO04-050-21-35	ASPrO04-050-30-35	ASPrO04-050-40-35	ASPrO04-050-46-35
75	ASPrO04-075-21-35	ASPrO04-075-30-35	ASPrO04-075-40-35	ASPrO04-075-46-35
100	ASPrO04-100-21-35	ASPrO04-100-30-35	ASPrO04-100-40-35	ASPrO04-100-46-35
125	ASPrO04-125-21-35	ASPrO04-125-30-35	ASPrO04-125-40-35	ASPrO04-125-46-35
150	ASPrO04-150-21-35	ASPrO04-150-30-35	ASPrO04-150-40-35	ASPrO04-150-46-35
10mm Guard pk 4	ASPrO04-G10-21-35	ASPrO04-G10-30-35	ASPrO04-G10-40-35	ASPrO04-G10-46-35

Guard Holder - HGH1

HORIZON C18

HPLC and UHPLC COLUMNS

Horizon C18 is a unique column based on ultra pure silica possessing excellent stability at extremes of high and low pH, Available in 1.6µm UHPLC format as well as 3µm & 5µm particle size for HPLC.



HORIZON HEADS UP

"It is possible to increase the retention and separation of basic compounds by increasing the pH of the mobile phase, the wide pH stability of the Horizon C18 column will accommodate this mobile phase pH adjustment"

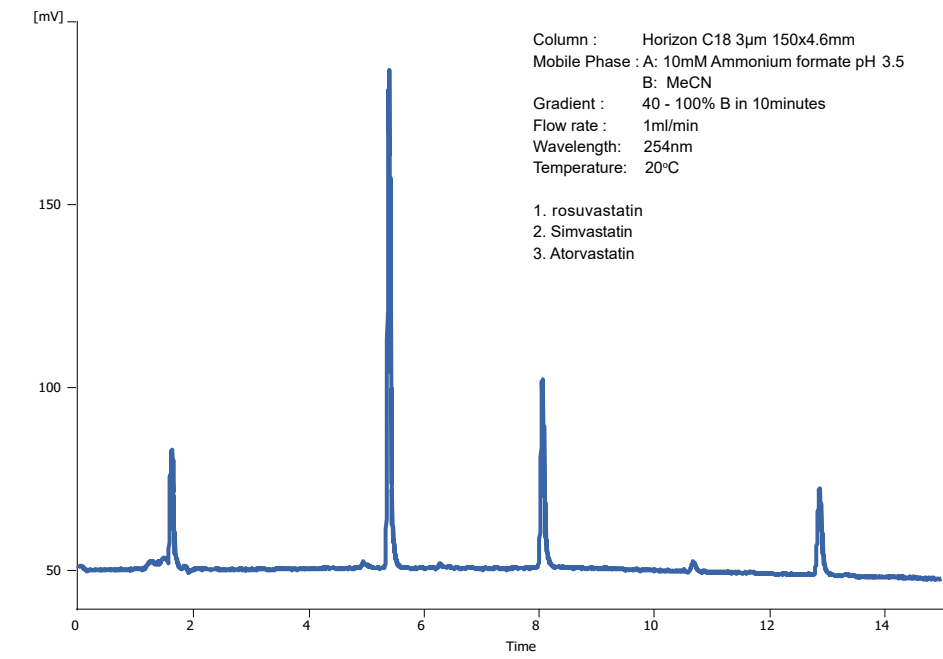
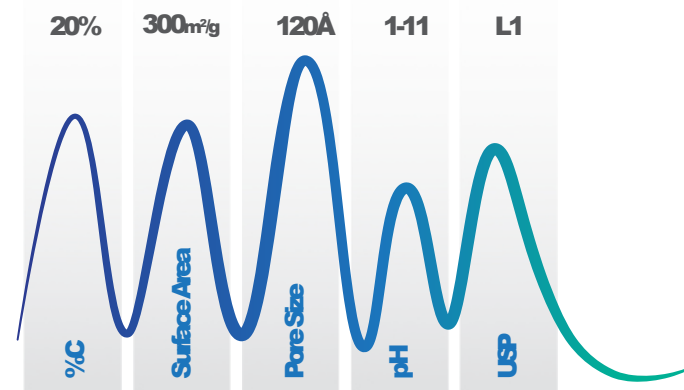

HORIZON C18

- Ultra pure high surface area silica in UHPLC and HPLC particle sizes
- excellent performance and stability at extremes of high and low pH
- excellent peak shapes and selectivity for difficult to analyse compounds
- Guaranteed column to column and batch to batch reproducibility

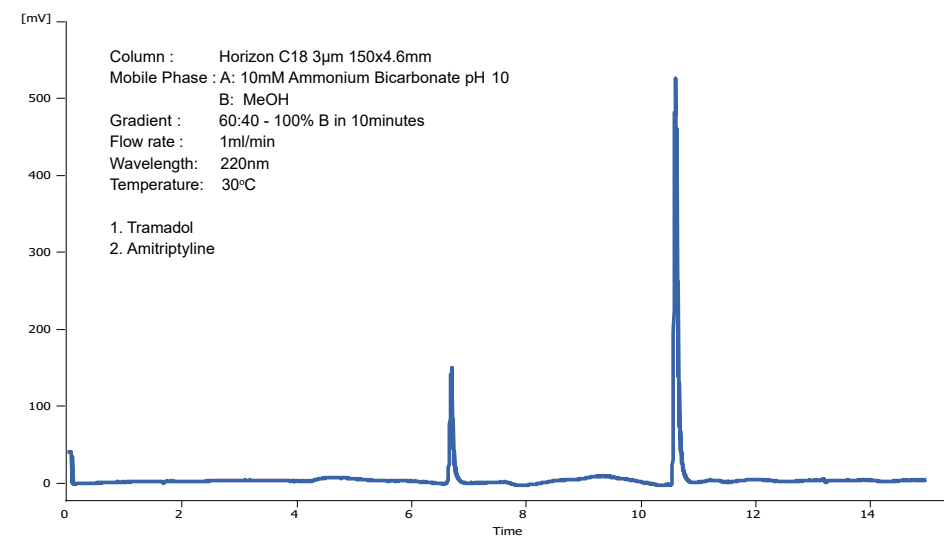

Column Length (mm)	Column Diameter (mm)			
	2.1	3.0	4.0	4.6
30	C18-030-21-DP	C18-030-30-DP	C18-030-40-DP	C18-030-46-DP
50	C18-050-21-DP	C18-050-30-DP	C18-050-40-DP	C18-050-46-DP
75	C18-075-21-DP	C18-075-30-DP	C18-075-40-DP	C18-075-46-DP
100	C18-100-21-DP	C18-100-30-DP	C18-100-40-DP	C18-100-46-DP
125	C18-125-21-DP	C18-125-30-DP	C18-125-40-DP	C18-125-46-DP
150	C18-150-21-DP	C18-150-30-DP	C18-150-40-DP	C18-150-46-DP
250	C18-250-21-DP	C18-250-30-DP	C18-250-40-DP	C18-250-46-DP
10mm Guard pk 4	C18-G10-21-DP	C18-G10-30-DP	C18-G10-40-DP	C18-G10-46-DP

replace DP with : 16 for 1.6µm 30 for 3µm 50 for 5µm Guard Holder - HG11

HORIZON C18/PFP

HPLC and UHPLC COLUMNS

Horizon C18/PFP columns offer the analyst increased selectivity changes for many applications including analysis of phenols, benzenes and amines. The unique combination of C18 and PFP means that hydrophobic retention can be maintained whilst extra selectivity and separation is achieved.



HORIZON HEADS UP

"Many separations are not achievable using a traditional hydrophobic C18 stationary phase, by using a C18/PFP column the additional pi-pi and dipole interactions can often provide the selectivity required"

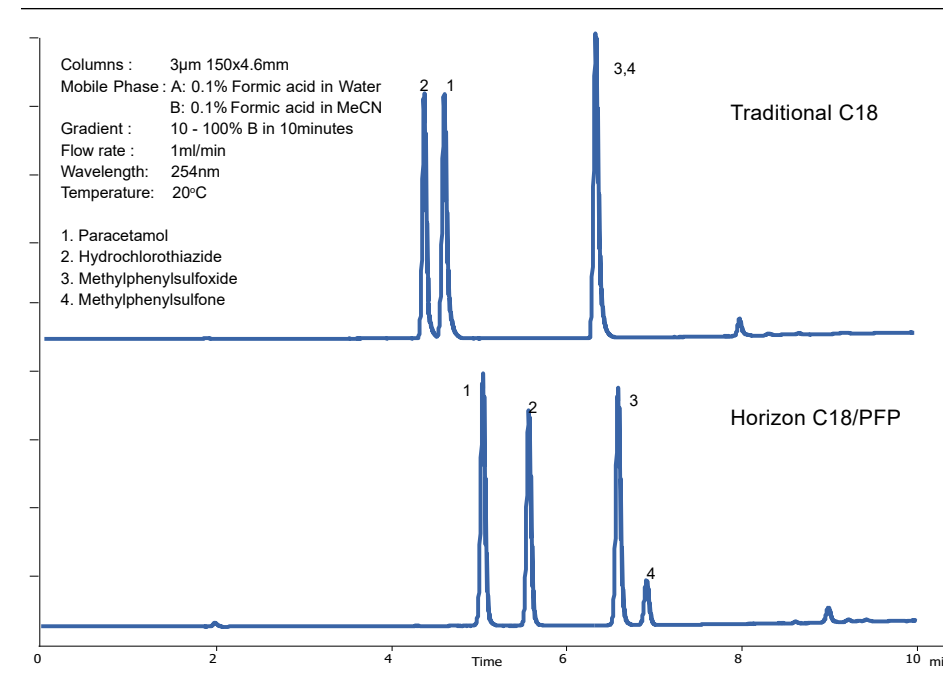
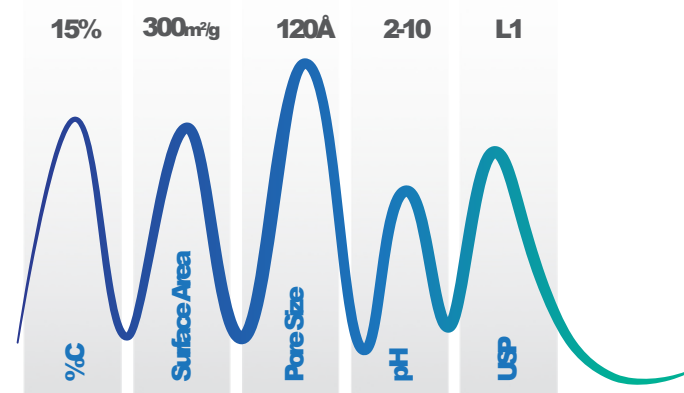

HORIZON C18/PFP

- Alternative selectivity L1 columns
- Offering strong hydrophobic, pi-pi and dipole interactions
- extended retention is achievable for halogenated compounds
- Available in 1.6µm UHPLC columns as well as analytical HPLC columns allowing simple method transfer
- Guaranteed column to column and batch to batch reproducibility

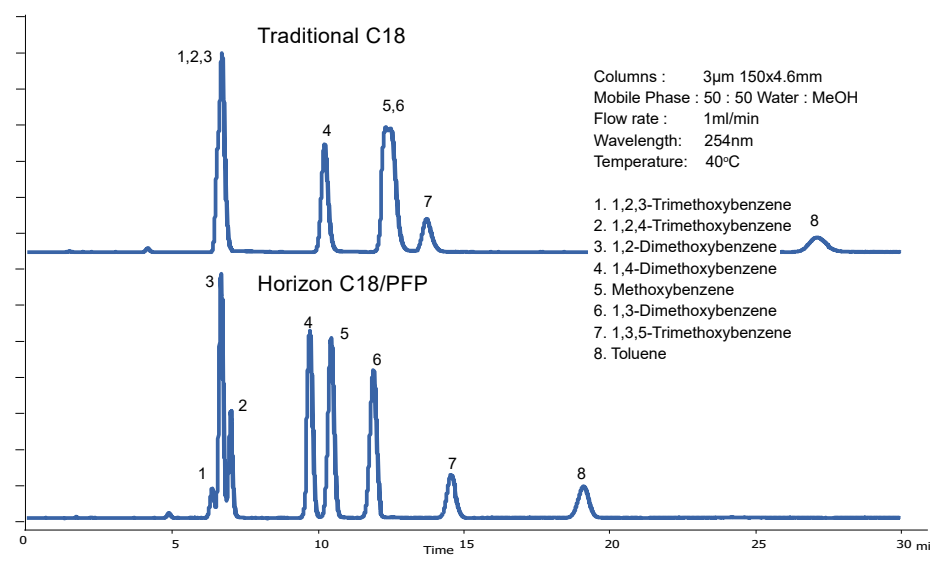

Column Length (mm)	Column Diameter (mm)			
	2.1	3.0	4.0	4.6
30	PF18-030-21-DP	PF18-030-30-DP	PF18-030-40-DP	PF18-030-46-DP
50	PF18-050-21-DP	PF18-050-30-DP	PF18-050-40-DP	PF18-050-46-DP
75	PF18-075-21-DP	PF18-075-30-DP	PF18-075-40-DP	PF18-075-46-DP
100	PF18-100-21-DP	PF18-100-30-DP	PF18-100-40-DP	PF18-100-46-DP
125	PF18-125-21-DP	PF18-125-30-DP	PF18-125-40-DP	PF18-125-46-DP
150	PF18-150-21-DP	PF18-150-30-DP	PF18-150-40-DP	PF18-150-46-DP
250	PF18-250-21-DP	PF18-250-30-DP	PF18-250-40-DP	PF18-250-46-DP
10mm Guard pk 4	PF18-G10-21-DP	PF18-G10-30-DP	PF18-G10-40-DP	PF18-G10-46-DP

replace DP with : 16 for 1.6µm

30 for 3µm

50 for 5µm

Guard Holder - HG11

HORIZON AQUA C18

HPLC and UHPLC COLUMNS

Polar endcapped C18 technology used in Horizon Aqua C18 columns means it can be used in 100% aqueous mobile phase for the retention of polar compounds.



HORIZON HEADS UP

"The development of Aqua C18 technology has been applied to many problematic applications. This is the 'go to' column for the analysis of vitamins, anti-coagulants, HIV drugs, catecholamines, steroids and anti-depressants"

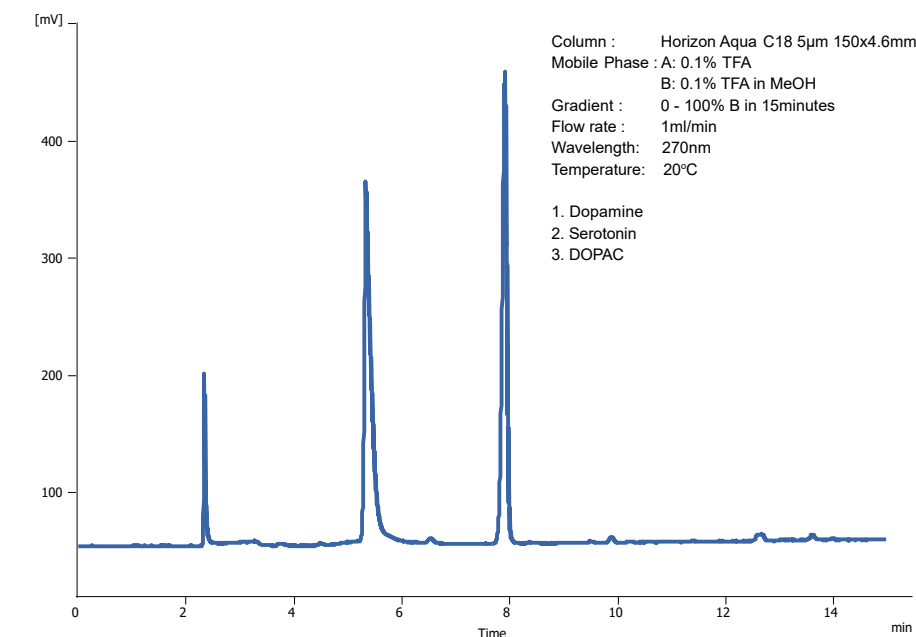
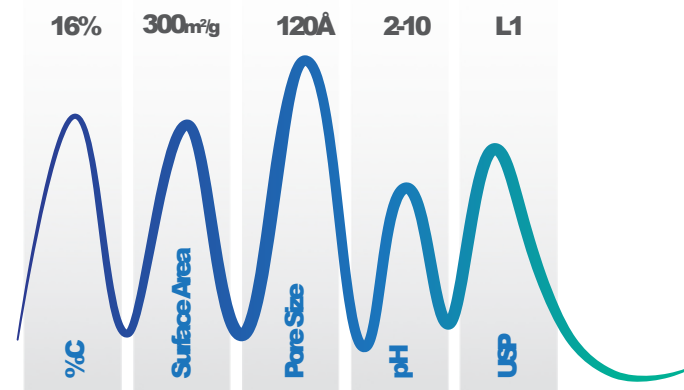

HORIZON AQUAC18

- Ultra pure silica in UHPLC and HPLC particle sizes
- excellent peak shapes and column lifetime
- resistant to retention loss caused by highly aqueous mobile phase conditions
- Analysis of polar compounds including polar acids and bases
- Guaranteed column to column and batch to batch reproducibility
- Available in 1.6µm UHPLC format and 3µm & 5µm particle size for HPLC

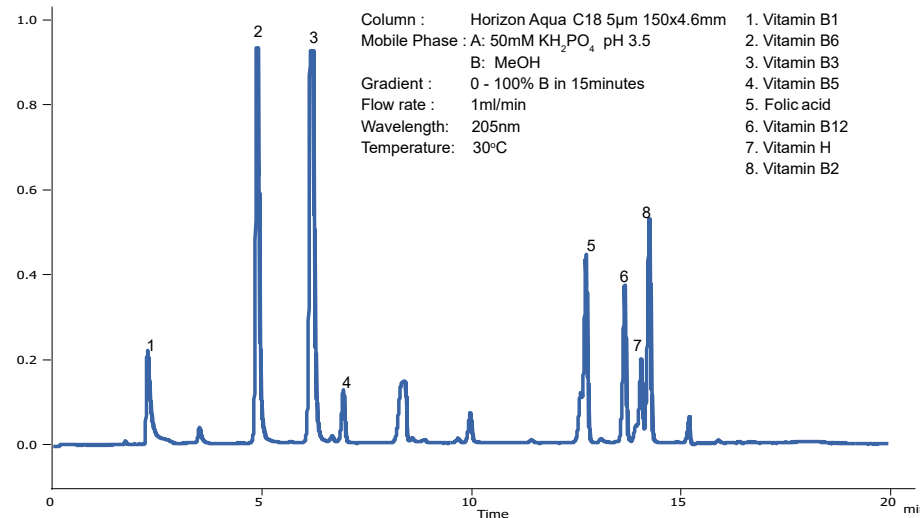

Column Length (mm)	Column Diameter (mm)			
	2.1	3.0	4.0	4.6
30	AQUA-030-21-DP	AQUA-030-30-DP	AQUA-030-40-DP	AQUA-030-46-DP
50	AQUA-050-21-DP	AQUA-050-30-DP	AQUA-050-40-DP	AQUA-050-46-DP
75	AQUA-075-21-DP	AQUA-075-30-DP	AQUA-075-40-DP	AQUA-075-46-DP
100	AQUA-100-21-DP	AQUA-100-30-DP	AQUA-100-40-DP	AQUA-100-46-DP
125	AQUA-125-21-DP	AQUA-125-30-DP	AQUA-125-40-DP	AQUA-125-46-DP
150	AQUA-150-21-DP	AQUA-150-30-DP	AQUA-150-40-DP	AQUA-150-46-DP
250	AQUA-250-21-DP	AQUA-250-30-DP	AQUA-250-40-DP	AQUA-250-46-DP
10mm Guard pk 4	AQUA-G10-21-DP	AQUA-G10-30-DP	AQUA-G10-40-DP	AQUA-G10-46-DP

replace DP with : 16 for 1.6µm 30 for 3µm 50 for 5µm Guard Holder - HG11

HORIZON C8

HPLC and UHPLC COLUMNS

- Great performance column for method development
- Less hydrophobic than classical C18 columns
- excellent peak shape and stability
- 1.6µm Horizon C8 columns available



- %C - 12%
- Surface area - 300 m²/g
- Pore size - 120Å
- pH range - 2-10
- USP - L7

Column Length (mm)	Column Diameter (mm)			
	2.1	3.0	4.0	4.6
30	C8-030-21-DP	C8-030-30-DP	C8-030-40-DP	C8-030-46-DP
50	C8-050-21-DP	C8-050-30-DP	C8-050-40-DP	C8-050-46-DP
75	C8-075-21-DP	C8-075-30-DP	C8-075-40-DP	C8-075-46-DP
100	C8-100-21-DP	C8-100-30-DP	C8-100-40-DP	C8-100-46-DP
125	C8-125-21-DP	C8-125-30-DP	C8-125-40-DP	C8-125-46-DP
150	C8-150-21-DP	C8-150-30-DP	C8-150-40-DP	C8-150-46-DP
250	C8-250-21-DP	C8-250-30-DP	C8-250-40-DP	C8-250-46-DP
10mm Guard pk 4	C8-G10-21-DP	C8-G10-30-DP	C8-G10-40-DP	C8-G10-46-DP

replace DP with : 16 for 1.6µm

30 for 3µm

50 for 5µm

Guard Holder - HGH1

HORIZON HILIC

HPLC and UHPLC COLUMNS

- reproducible Diol bonded stationary phase
- Improved separation and selectivity of polar compounds
- Separation of highly hydrophilic compounds
- excellent retention and MS sensitivity of polar compounds
- 1.6µm, 3µm and 5µm Horizon HILIC columns available



- %C - 4%
- Surface area - 300 m²/g
- Pore size - 120Å
- pH range - 2-8
- USP - L20

Column Length (mm)	Column Diameter (mm)			
	2.1	3.0	4.0	4.6
30	HILIC-030-21-DP	HILIC-030-30-DP	HILIC-030-40-DP	HILIC-030-46-DP
50	HILIC-050-21-DP	HILIC-050-30-DP	HILIC-050-40-DP	HILIC-050-46-DP
75	HILIC-075-21-DP	HILIC-075-30-DP	HILIC-075-40-DP	HILIC-075-46-DP
100	HILIC-100-21-DP	HILIC-100-30-DP	HILIC-100-40-DP	HILIC-100-46-DP
125	HILIC-125-21-DP	HILIC-125-30-DP	HILIC-125-40-DP	HILIC-125-46-DP
150	HILIC-150-21-DP	HILIC-150-30-DP	HILIC-150-40-DP	HILIC-150-46-DP
250	HILIC-250-21-DP	HILIC-250-30-DP	HILIC-250-40-DP	HILIC-250-46-DP
10mm Guard pk 4	HILIC-G10-21-DP	HILIC-G10-30-DP	HILIC-G10-40-DP	HILIC-G10-46-DP

replace DP with : 16 for 1.6µm

30 for 3µm

50 for 5µm

Guard Holder - HGH1

HORIZON PHENYL

HPLC and UHPLC COLUMNS

- Suitable for a wide range of aromatic compounds
- Separation of vitamins, herbicides, positional isomers
- Strong pi-pi interactions affording alternative selectivity
- 1.6µm, 3µm and 5µm Horizon Phenyl available



- %C - 12%
- Surface area - 300 m²/g
- Pore size - 120Å
- pH range - 2-8
- USP - L11

Column Length (mm)	Column Diameter (mm)			
	2.1	3.0	4.0	4.6
30	PHeNYL-030-21-DP	PHeNYL-030-30-DP	PHeNYL-030-40-DP	PHeNYL-030-46-DP
50	PHeNYL-050-21-DP	PHeNYL-050-30-DP	PHeNYL-050-40-DP	PHeNYL-050-46-DP
75	PHeNYL-075-21-DP	PHeNYL-075-30-DP	PHeNYL-075-40-DP	PHeNYL-075-46-DP
100	PHeNYL-100-21-DP	PHeNYL-100-30-DP	PHeNYL-100-40-DP	PHeNYL-100-46-DP
125	PHeNYL-125-21-DP	PHeNYL-125-30-DP	PHeNYL-125-40-DP	PHeNYL-125-46-DP
150	PHeNYL-150-21-DP	PHeNYL-150-30-DP	PHeNYL-150-40-DP	PHeNYL-150-46-DP
250	PHeNYL-250-21-DP	PHeNYL-250-30-DP	PHeNYL-250-40-DP	PHeNYL-250-46-DP
10mm Guard pk 4	PHeNYL-G10-21-DP	PHeNYL-G10-30-DP	PHeNYL-G10-40-DP	PHeNYL-G10-46-DP

replace DP with : 16 for 1.6µm

30 for 3µm

50 for 5µm

Guard Holder - HGH1

HORIZON AMINO

HPLC and UHPLC COLUMNS

- Offers polar selectivity under normal phase, reversed phase, ion-exchange or HILIC conditions
- Ideal for analysis of sugars, anionic or hydrogen bonding compounds
- 1.6µm, 3µm and 5µm Horizon Amino available



- %C - 5%
- Surface area - 300 m²/g
- Pore size - 120Å
- pH range - 2-8
- USP - L8

Column Length (mm)	Column Diameter (mm)			
	2.1	3.0	4.0	4.6
30	AMINO-030-21-DP	AMINO-030-30-DP	AMINO-030-40-DP	AMINO-030-46-DP
50	AMINO-050-21-DP	AMINO-050-30-DP	AMINO-050-40-DP	AMINO-050-46-DP
75	AMINO-075-21-DP	AMINO-075-30-DP	AMINO-075-40-DP	AMINO-075-46-DP
100	AMINO-100-21-DP	AMINO-100-30-DP	AMINO-100-40-DP	AMINO-100-46-DP
125	AMINO-125-21-DP	AMINO-125-30-DP	AMINO-125-40-DP	AMINO-125-46-DP
150	AMINO-150-21-DP	AMINO-150-30-DP	AMINO-150-40-DP	AMINO-150-46-DP
250	AMINO-250-21-DP	AMINO-250-30-DP	AMINO-250-40-DP	AMINO-250-46-DP
10mm Guard pk 4	AMINO-G10-21-DP	AMINO-G10-30-DP	AMINO-G10-40-DP	AMINO-G10-46-DP

replace DP with : 16 for 1.6µm

30 for 3µm

50 for 5µm

Guard Holder - HGH1

HORIZON CYANO

HPLC and UHPLC COLUMNS

- Offers unique selectivity under normal phase or reversed phase conditions
- Provides pi-pi and hydrogen bonding interactions
- Analysis of carboxyl, carbonyl or amine compounds
- 1.6µm, 3µm and 5µm Horizon Cyano available



- %C - 7%
- Surface area - 300 m²/g
- Pore size - 120Å
- pH range - 1-6
- USP - L10

Column Length (mm)	Column Diameter (mm)			
	2.1	3.0	4.0	4.6
30	CYANO-030-21-DP	CYANO-030-30-DP	CYANO-030-40-DP	CYANO-030-46-DP
50	CYANO-050-21-DP	CYANO-050-30-DP	CYANO-050-40-DP	CYANO-050-46-DP
75	CYANO-075-21-DP	CYANO-075-30-DP	CYANO-075-40-DP	CYANO-075-46-DP
100	CYANO-100-21-DP	CYANO-100-30-DP	CYANO-100-40-DP	CYANO-100-46-DP
125	CYANO-125-21-DP	CYANO-125-30-DP	CYANO-125-40-DP	CYANO-125-46-DP
150	CYANO-150-21-DP	CYANO-150-30-DP	CYANO-150-40-DP	CYANO-150-46-DP
250	CYANO-250-21-DP	CYANO-250-30-DP	CYANO-250-40-DP	CYANO-250-46-DP
10mm Guard pk 4	CYANO-G10-21-DP	CYANO-G10-30-DP	CYANO-G10-40-DP	CYANO-G10-46-DP

replace DP with : 16 for 1.6µm

30 for 3µm

50 for 5µm

Guard Holder - HGH1

GOING BIGGER...GOING SMALLER

> Nano Capillaries - 75µm i.d.

Nano capillaries offer improved detection sensitivity for applications where limited sample availability is an issue.

- Available for both fully porous (Horizon) and core-shell (Aurashell) particles
- Full range of bonded phase chemistries available
- Multiple pore sizes available 120Å, 200Å and 300Å
- Suitable for Pharmacokinetics, trace analysis and Proteomic work
- Capillaries can be supplied with either 1/16th or 1/32nd fittings
- Standard and custom made capillary lengths available

Contact your local distributor for more details

Generate Capillary part number:

Phase	Length (mm)	Code	Particle Size (dp)
C18	050	CAP75	16
C18	100	CAP75	27
AQUA	150	CAP75	30
PF18	250	CAP75	50
PEP18			
PRO04			

example : C18-100-CAP75-30

> Preparative Columns

- Ultra high purity silica 5µm and 10µm
- High surface area silica provides high sample loading and excellent sample recovery
- Available in a wide range of column dimensions and particle sizes
- Full range of Horizon phase chemistries available in preparative column format
- Guard cartridges available for all column dimensions, to prolong preparative column lifetime

replace XXXwith -

- C18 - Horizon C18
- AQUA - Horizon AQUA
- PF18 - Horizon C18/PFP
- C8 - Horizon C8
- HILIC - Horizon HILIC
- PHeNYL - Horizon Phenyl
- AMINO - Horizon Amino
- PeP18 - Horizon PeP C18
- PrO04 - HorizonPrO C4

Column Length	Column Diameter	
	10mm	21.2mm
50	XXX-050-100-DP	XXX-050-212-DP
100	XXX-100-100-DP	XXX-100-212-DP
150	XXX-150-100-DP	XXX-150-212-DP
250	XXX-250-100-DP	XXX-250-212-DP

replace DP with : 50 for 5µm

100 for 10µm

HORIZON PEP C18

WIDE PORE HPLC COLUMNS

- Designed for peptide analysis and peptide mapping
- Ultra high purity silica
- excellent chemical stability
- excellent peak shapes and reproducibility
- 3µm and 5µm Horizon Pep C18 columns available



- %C - 10%
- Surface area - 175 m²/g
- Pore size - 200Å
- pH range - 1-9
- USP - L1

Column Length (mm)	Column Diameter (mm)			
	2.1	3.0	4.0	4.6
30	PeP18-030-21-DP	PeP18-030-30-DP	PeP18-030-40-DP	PeP18-030-46-DP
50	PeP18-050-21-DP	PeP18-050-30-DP	PeP18-050-40-DP	PeP18-050-46-DP
75	PeP18-075-21-DP	PeP18-075-30-DP	PeP18-075-40-DP	PeP18-075-46-DP
100	PeP18-100-21-DP	PeP18-100-30-DP	PeP18-100-40-DP	PeP18-100-46-DP
125	PeP18-125-21-DP	PeP18-125-30-DP	PeP18-125-40-DP	PeP18-125-46-DP
150	PeP18-150-21-DP	PeP18-150-30-DP	PeP18-150-40-DP	PeP18-150-46-DP
250	PeP18-250-21-DP	PeP18-250-30-DP	PeP18-250-40-DP	PeP18-250-46-DP
10mm Guard pk 4	PeP18-G10-21-DP	PeP18-G10-30-DP	PeP18-G10-40-DP	PeP18-G10-46-DP

replace DP with : 30 for 3µm 50 for 5µm Guard Holder - HG1

HORIZON PRO C4

WIDE PORE HPLC COLUMNS

- Wide range of polypeptide and protein analysis possible
- Ultra high purity silica and excellent chemical stability
- excellent peak shapes and reproducibility
- 3µm and 5µm Horizon PrO C4 columns available



- %C - 3%
- Surface area - 100 m²/g
- Pore size - 300Å
- pH range - 1-9
- USP - L26

Column Length (mm)	Column Diameter (mm)			
	2.1	3.0	4.0	4.6
30	PrO04-030-21-DP	PrO04-030-30-DP	PrO04-030-40-DP	PrO04-030-46-DP
50	PrO04-050-21-DP	PrO04-050-30-DP	PrO04-050-40-DP	PrO04-050-46-DP
75	PrO04-075-21-DP	PrO04-075-30-DP	PrO04-075-40-DP	PrO04-075-46-DP
100	PrO04-100-21-DP	PrO04-100-30-DP	PrO04-100-40-DP	PrO04-100-46-DP
125	PrO04-125-21-DP	PrO04-125-30-DP	PrO04-125-40-DP	PrO04-125-46-DP
150	PrO04-150-21-DP	PrO04-150-30-DP	PrO04-150-40-DP	PrO04-150-46-DP
250	PrO04-250-21-DP	PrO04-250-30-DP	PrO04-250-40-DP	PrO04-250-46-DP
10mm Guard pk 4	PrO04-G10-21-DP	PrO04-G10-30-DP	PrO04-G10-40-DP	PrO04-G10-46-DP

replace DP with : 30 for 3µm 50 for 5µm Guard Holder - HG1



HORIZON
CHROMATOGRAPHY LTD.

www.horizonhplc.com

JASCO France
17 rue des Cerisiers
91090 LISSES
jascofrance@jascofrance.fr
Téléphone : 01 64 97 09 60
www.jascofrance.fr